

RE:FELT

# BAFFLE LIGHTING LINEAR 2400

## INSTALLATION GUIDE

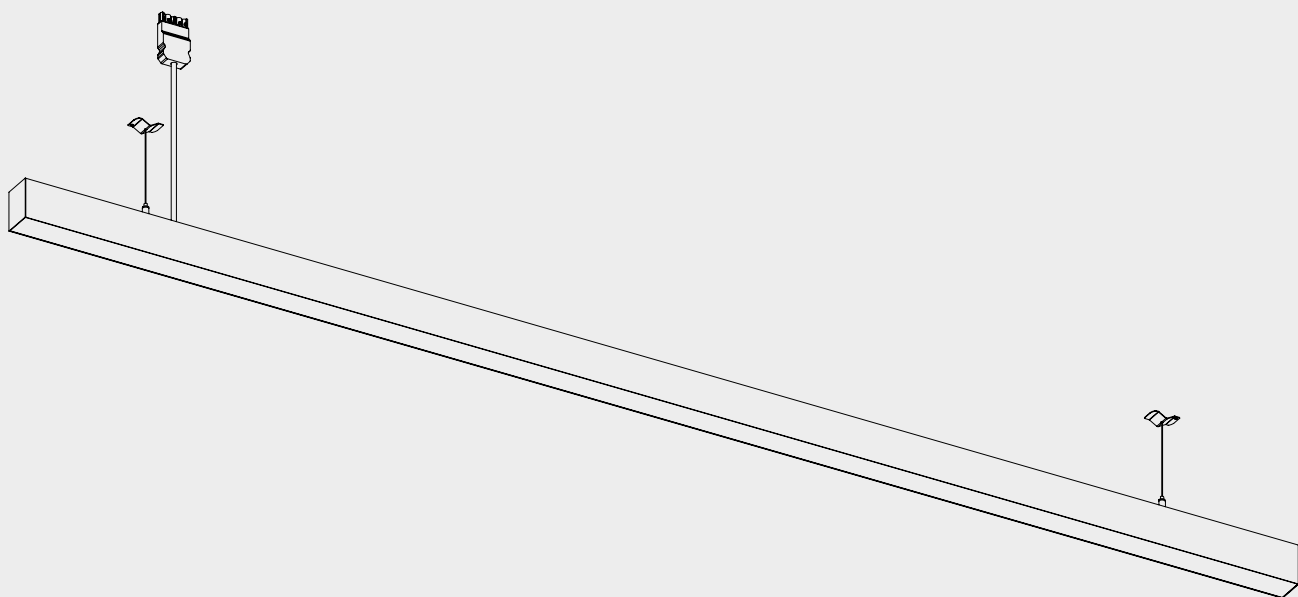

## TECHNICAL DATA

---

### Light source

Light Output	2150lm
Voltage	99V-260V
Power	25W
Colour temperature	4000K
CRI	90
Dimmable	DALI
Material	Aluminium
Weight	6 kg
Diffuser	Microprismatic polycarbonate
Dimensions	2255 x 50 x 69

## INTRODUCTION

---

- This guide is applicable for Baffle Linear and Baffle Spots
- Follow the instructions for a safe installation
- Make sure the power has been switched off before installing or cleaning the product.
- Maintain interior lighting with a dry cloth or brush. Do not use alcohol or any other solvent to clean the product. Keep all electrical components dry.

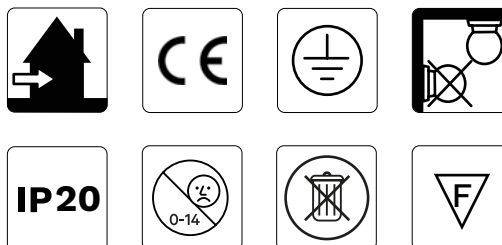

## SAFETY PRECAUTIONS

---

The user must observe the safety notes and warnings in order to maintain this status and to ensure safe operation. Never attempt to open the device other than described in this manual. The LED luminaire cannot be repaired; this part must be immediately disposed in case of a defect. Ensure sufficient ventilation of the device. Never cover it during operation. Do not install in reach of children or animals. The entire product may not be modified or adapted. These safety notes must be observed in all cases! Any warranty claim is void in the case of damages caused by non-observance of these operating instructions. We are not liable for consequential damages or for damages to property or persons caused by non-observance of the safety notes and improper operation of the device. Safe operation is not possible anymore, if:

- the LED luminaire has visible damages
- the LED luminaire does not work anymore

### Attention!

- Installation only by persons with electro technical knowledge and experience.

# INSTALLATION

① Make sure the power is switched off

② Parts required

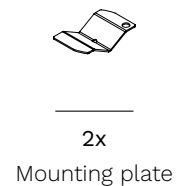
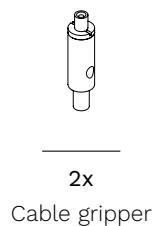
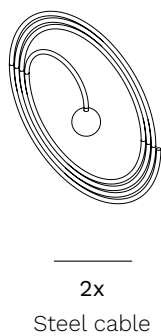
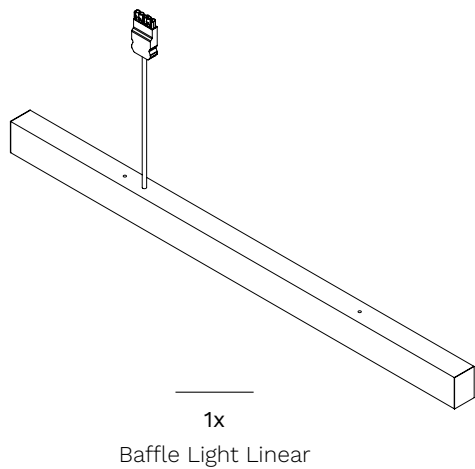

③ Thread the mounting plate onto the steel cable

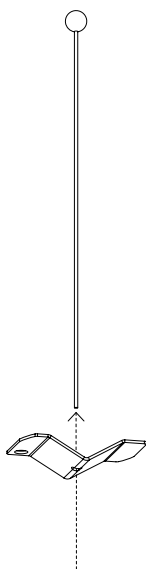

④ Push the spacer slightly upwards with the mounting plate and rotate the mounting plate 90°

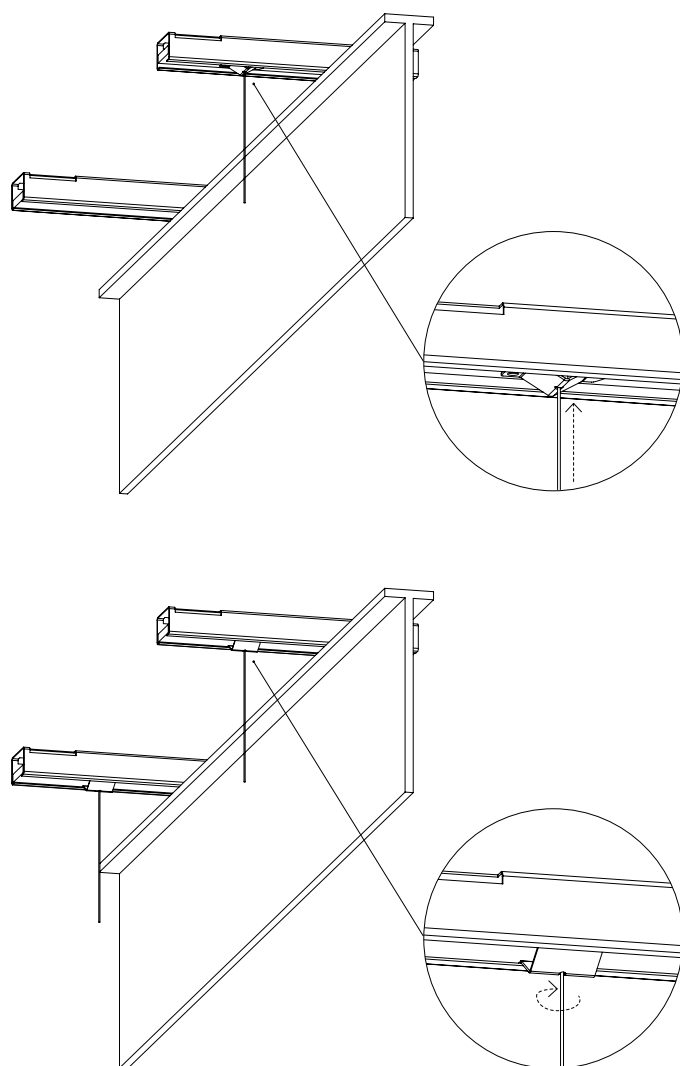

- ⑤ Push the steel cable into the cable adjusters and hang the lamp at the desired height

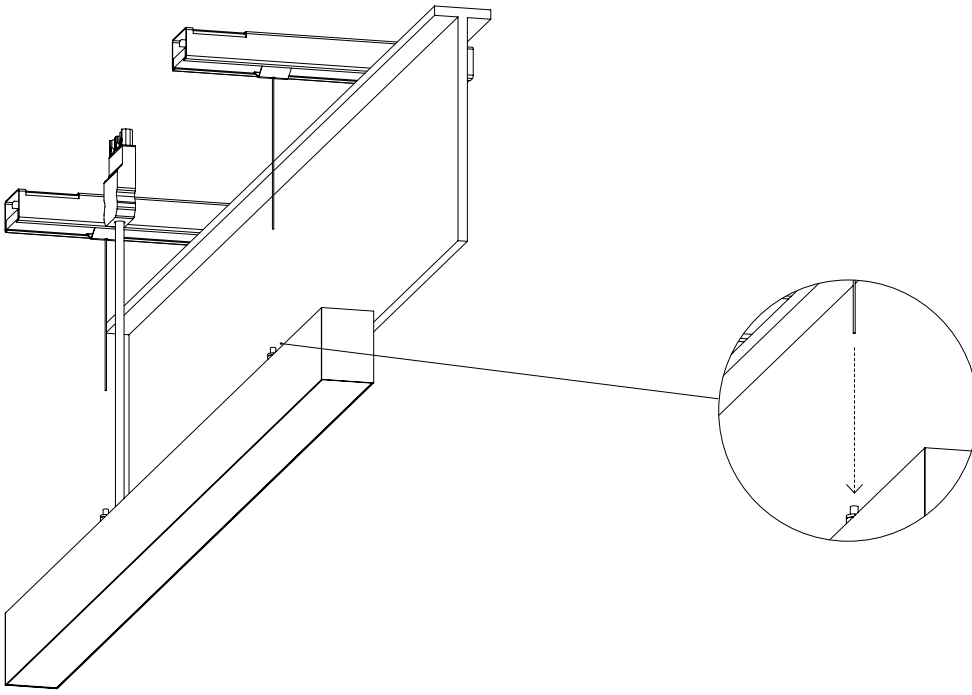

- ⑥ Connect the lamp using the 5-pole plug. You are all set!

